

Clip On Spray Nozzles

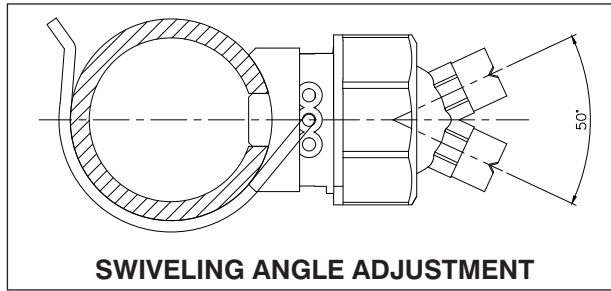

SPRAY CHARACTERISTICS :

These nozzles simply clip over a pre-drilled pipe (9/16" dia. hole) and are available with a variety of easy clip, in various spray patterns, flow rates and spray angles. Retaining cap holds the tip in position, even when the nozzle is jarred or vibrated.

Range :

Flow rate (lpm) at 2 bar Pressure : 1 LPM to 40 LPM.
Connection : 1/4", 3/8" BSP

Construction :

Made of corrosion-resistant plastic and stainless steel. Heavy-duty spring clip good to 100 p.s.i. at 175°F. A 316SS clip is also available, if required. Simple quick assembling, Ball joint, omnidirectional swivelling range of 30° Simple quick assembling.

Applications :

Part Cleaning, phosphating, degreasing, rinsing, surface treatment. Easy adjusting and cleaning.

THE SPRAYTECH "CLIP-ON" ASSEMBLY

The spring clamp is the heaviest and most durable used in the industries. It provides long services at pressures up to 100 p.s.i.

Hundreds of standard nozzle balls and spray tip options are available when using our female threaded ball.

The cap has strong butress threads and is made from glass filled polypropylene.

Standard O-Ring seal is EPDM. Burna-N, Viton®, and special "retrofit" seals are available.

Square fitting glass filled polypropylene bodies are available in various pipe sizes and are good up to 175°F.

"Clip-on" assembly holds the ball securely in alignment to prevent movement when the cap is tightened.

The "clip-on" assembly is optional on all Spraytech adjustable nozzles.

QUICK RELEASE CLIP-ON ADAPTERS

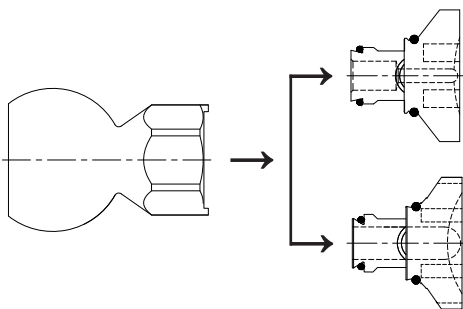

Any quick release type spray nozzle

THREADED BALL

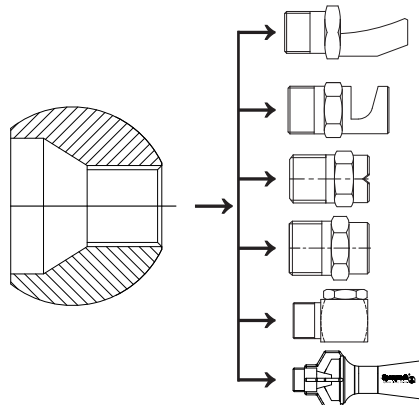

High Impact Flat Spray Nozzle

Flood Spray Nozzle

Flat Spray Nozzle

Full Cone Spray Nozzle

Hollow Cone Spray Nozzle

Tank Mixing Eductor

Clip On Type Assembly With Flat Spray Nozzles



Specially purpose dedicated designed clipon type spray nozzle allows to mounting and removal from spray riser / header without efforts and spanners for cleaning purposes. and ball type body of spray nozzle provides swivel type joint to adjust in various directions.

Clipon type spray nozzles are enhanced with different sized clips (made of spring steel) which provides strong clamping on riser/ header. Clips are available in 1", 1-1/4", 1-1/2", 2" ID etc sizes.

- Ball body type spray nozzles allow to set in various spray directions as per requirement for surface to be cleaned.
- Clips used for clamping withstand to the pressure of 4 BARG. (60 psi)
- Made of PP material which is resistant to chemicals, and give a long running life.
- Flat type spray tips give high impact with wide coverage.
- This type of spray nozzles can be used to spray Phospates
- Maximum temperature of 180°F (82°C).

In addition to swivel ball type body, quick release type flat spray tip allow to get dismantled

from clipon assembly without disturbing previous directional settings of assembly.

- Easy to mount on clipon assembly without disturbing previous directional settings
- Flat type spray tips give high impact with wide coverage.
- Clips used for clamping with stand to the pressure of 4 BARG. (60 psi)
- Made of PP material which is resistant to chemicals, and give a long running life.
- Maximum temperature of 180°F (82°C).



Quick Fit Rises & Header Manifolds

Our products for surface pretreatment plants is complete inclusive of the riser pipes, header manifolds as per the system manufacturers drawings & designs. As per the requirement of the system & equipment builders, Spraytech has developed all necessary parts for the professional assembly of the header manifolds and riser pipes. These are customized designs, to suit the process and plant layouts. All the header manifolds and riser pipes are also supplied with Spraytech fittings.

The header manifolds are fabricated to customized designed & plant layout. Typical manifold and risers mounted in a pre-treatment tunnel appears in the photo.

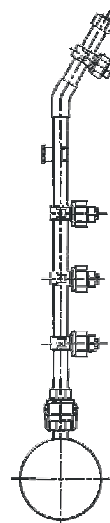

Material : PP : Polypropylene ; AISI 304 Stainless Steel

TE Series Tank Mixing Eductor

Design Features

- Effective, economical way to Circulate liquids in closed or open tanks
- No Moving parts
- Inherently clog resistant
- Requires minimal maintenance
- Nozzles operation creates multiplying effect on fluid flow

Spray Characteristics

- Cone -shaped plume Flow rates: 26.7 to 12000 L/min (motive)
- The volume of discharge liquid will be 3-5 times greater than the motive liquid pumped.
- It's unique venturi design ensures proper mixing of tank Solution.



Plastic Versions



Metal Versions

Eductors have a unique venturi design which enables smaller pumps to circulate large volumes of tank solution. The eductor will circulate four to five gallons of solution for each gallon pumped. Eductors are used for mixing chemicals, suspending solids, adjusting pH, "sweeping" debris or sludge toward a filter intake and many other useful applications.

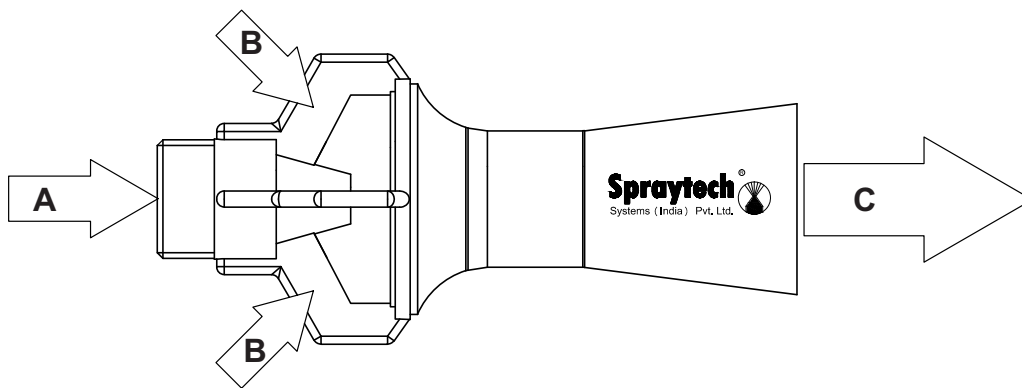

Application

- Plating Tanks
- Phosphating Tanks
- Fertilizer tanks
- Pulp Tanks
- Sludge Tanks
- Paint Booths
- Anodizing Tanks
- Cooling Towers
- Decorative Fountains

A = Inlet Flow Rate

B = Entrained Flow Rate

C = (A+B) Out Flow

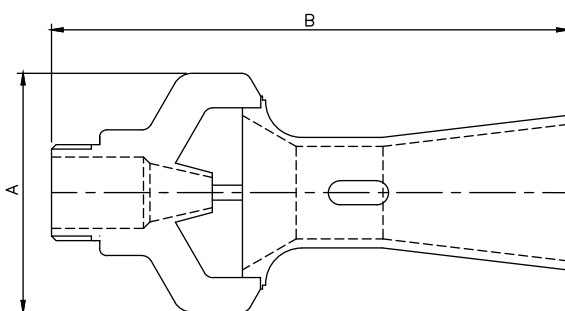

Plastic Versions

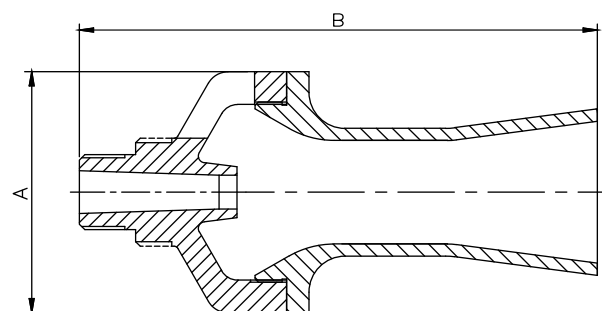

Metal Versions

TE Series Tank Mixing Eductor

PLASTIC												
Connection Size BSPT / NPT		Part Number	KFavor	Motive Flow Rate LPM @ BAR							Dimensions (mm)	
				0.7 bar	1 bar	1.5 bar	2 bar	2.5 bar	3 bar	3.5 bar	A	B
Male	3/8	TE73	33.2	27.8	33.2	40.7	47	52.5	57.6	62.2	54	114
	1/2	TE120	54.4	45.4	54.3	66.5	76.7	85.8	94	101	64	165
	3/4	TE137	62.4	52.2	62.4	76.4	88.2	98.6	108	117	73	162
	1	TE240	109	90.8	108	133	153	172	188	203	89	241
	1 1/2	TE340	155	130	155	190	219	245	269	290	114	248
Standard Material : Glass-filled Polypropylene											Dimensions are approximate	

METAL												
Connection Size BSPT / NPT		Part Number	KFavor	Motive Flow Rate LPM @ BAR							Dimensions (mm)	
				0.7 bar	1 bar	1.5 bar	2 bar	3 bar	5 bar	7 bar	A	B
Male	3/8	TE70	31.9	26.7	31.9	39.1	45.1	55.3	71.4	84.4	49.5	115
	1/2	TE110	50.1	41.9	50.1	61.3	70.8	87.0	112	132	59.5	150
	3/4	TE150	68.4	57.2	68.4	83.7	96.7	118	153	181	69.5	167
	1	TE230	105	87.7	105	128	148	182	234	277	83	200
Female	1 1/2	TE320	146	122	146	179	206	253	326	386	97	233
	2	TE620	282	236	282	345	399	489	631	746	121	286
	3	TE1500	684	572	684	837	967	1180	1530	1810	165	492
Flanged	4	TE2510	1130	950	1130	1390	1610	1970	2540	3000	213	864
	6	TE6010	2720	2270	2720	3330	3840	4710	6080	7190	321	1320
	8	TE10050	4550	3800	4550	5570	6430	7870	10200	12000	416	1730
Motive Flow Rate (LPM) = K √bar												
Standard Material: Brass, Carbon Steel, S.S.304, 310, 316, PVC, PVDF, P.P. Size from 1/4" to 3" NPT, BSPT, BSPP												

METAL													
Connection Size BSPT / NPT		Part Number		Motive Flow Rate Litters Per Minutes @BAR							Dimensions (mm)		
				0.7 bar	1 bar	1.5 bar	2 bar	2.5 bar	3 bar	3.5 bar	4 bar	A	B
Male	1/4	TE60	Intel Flow Rate (l/min) "A"	13.5	16	19.5	23	25	28	30	33	54	114
	3/8	TE73		27.8	33.2	40.7	47	52.5	57.6	62.2	67	49.5	115
	1/2	TE120		45.4	54.3	66.5	76.7	85.8	94	101	109	59.5	150
	3/4	TE137		52.2	62.4	76.4	88.2	98.6	108	117	126	73	162
	1	TE240		90.8	108	133	153	172	188	203	218	89	241
	1 1/2	TE340		130	155	190	219	245	269	290	313	114	248
	1/4	TE60	Entrained Flow Rate (l/min) "B"	54	64	78	92	100	112	120	132		
	3/8	TE73		111	132	163	188	210	230	249	268		
	1/2	TE120		182	217	307	307	343	376	404	436		
	3/4	TE137		209	250	353	353	394	432	468	504		
	1	TE240		363	432	612	612	688	752	812	872		
	1 1/2	TE340		520	620	876	876	980	1076	1160	1252		
	1/4	TE60	Total Out-Flow Rate (l/min) "A+B"	67.5	80	115	115	125	140	150	165		
	3/8	TE73		138.8	165.2	235	235	262.5	287.6	311.2	335		
	1/2	TE120		227.4	271.3	383.7	383.7	428.8	470	505	545		
	3/4	TE137		261.2	312.4	381.4	441.2	492.6	450	585	630		
1	TE240	453.8		540	665	765	860	940	1015	1090			
1 1/2	TE340	650		775	950	1095	1225	1345	1450	1565			

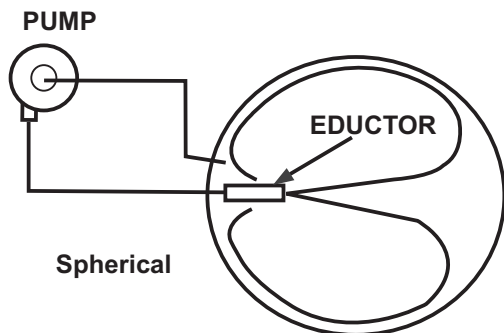

Figure 1
Educator in a round tank



Figure 2
Educators in a tank providing mixing.

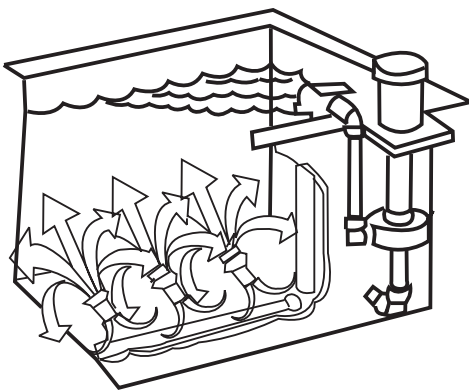

Figure 3
Multiple educator assembly

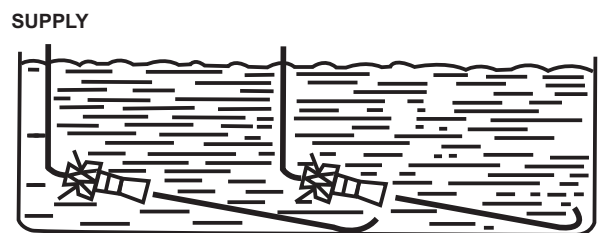

Figure 4
Educators in a tank maintaining suspension and mixing of solids.

Mounting

An educator can be mounted in any position. The supply line and manifold piping to multiple educators must be sized to supply uniform pressure to each educator. It is important that the educator be positioned within the tank to insure the free flow of liquid to be mixed into and out of the units. The greatest agitation occurs within the discharge plume; therefore, the discharge end should be aimed towards the most remote part of the tank. On the other hand, the intake end of the unit must be just far enough from the tank corner or wall to allow the free flow of liquid into the suction openings.

Tank shape and size influence the placement and number of educators required to maintain even agitation. With a spherical tank, a single educator mounted as shown in the Figure 1 illustration makes the best use of the mixing characteristics of the educator. With no corners to impede liquid flow, the liquid circulates evenly.

In simple mixing applications in a cylindrical, square or rectangular tank, not a plating tank, the angular intersection of stagnation in these areas. A single educator mounted as shown in Figure 2 will minimize this. For high agitation, use of multiple educators are recommended as shown in Figure 3.

A slight downward angle of the educators can be helpful in maintaining the velocity at the tank bottom which is necessary to keep solids in suspension for easier removal by a filter system. (See Figure 4)

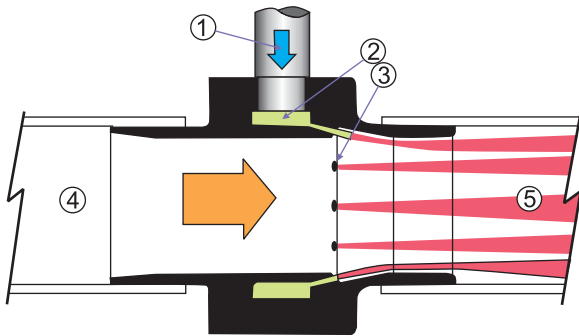

Compressed air flows through the inlet

(1) into an annular plenum chamber (2) It is then injected into the throat through directed nozzles (3) These jets of air create a vacuum at the intake (4) which draws material in and accelerates it through the unit (5) for conveying over long vertical or horizontal distances.

Air Conveyor is available in a number of styles, materials, and sizes. Each has a large, smooth, straight bore that allows as much material to pass through as possible. Infinite control of the flow rate through the Air conveyor can be controlled by a pressure regulator. Kits include a pressure regulator that is sized properly for flow.

The actual conveying rate is affected by the size, mass and geometry of the part to be conveyed along with the length, lift and number of bends in the hose, tube or pipe. These variables make it difficult to determine the exact conveying rate for any product, however, the application engineering can assist you by comparing the material you want to convey with something that has already been tested.

Air Conveyor Performance

80 PSIG (5.5 BAR)	Air Consumption		Vacuum	
	SCFM	SLPM	H2O	kPa
Model				
2710	10.7	303	-72	-18
4214	14.7	416	-42	-11
4225	25.9	733	-42	-11
3633	33	934	-36.8	-9
2845	45	1274	-28.5	-7
2358	58.5	1656	-23.5	-6
1468	68.5	1939	-14.7	-4
1395	95	2690	-13.6	-3.4
1012	128	3625	-10.5	-2.6

Air Conveyor Comparison		
Material Type	Temperature Rating	Corrosion Resistance
Aluminum	275° F (135° C)	Fair
Stainless Steel (Type 303)	400° F (204° C)	Good
Stainless Steel (Type 316)	400° F (204° C)	Excellent
High Temperature Stainless Steel (Type 303)	900° F (482° C)	Good

Applications :

- Hopper loading
- Fiber tensioning
- Material conveying
- Water/trim removal
- Chip removal
- Part transfer
- Filling operations

Adjustable Air Booster

Adjustable Air Booster

The air gap is infinitely adjustable which regulates the consumption and outlet flow from a "breeze" to a "blast". They are available in aluminum or in stainless steel for food service, higher temperatures (400°F/204°C), and corrosive applications. High Temperature Stainless Steel Air Boosters for temperatures up to 700°F (374°C) are also available.

Force and flow for the Adjustable Air Booster is changed by turning the exhaust end (with the knurled ring loose) to open or close the continuous air gap. When desired performance is obtained, the knurled ring can be tightened to lock the flow at that setting. In most cases, a .002" to .004" (0.05mm to 0.10mm) air gap is ideal.

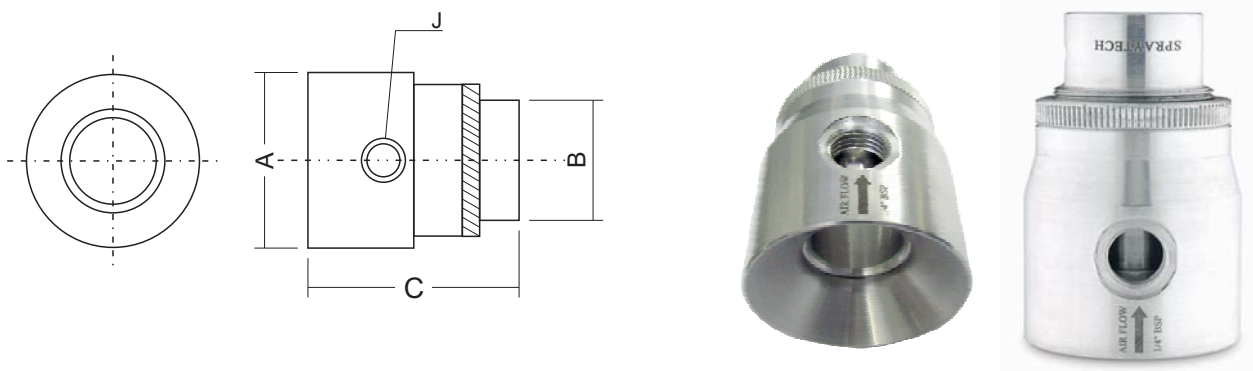

Adjustable Air Booster Performance at 80 PSIG (5.5 BAR)

MODEL	Air Consumption		Amplification	Air Volume at Outlet		Air Volume at 6" (152mm)		Sound Level
	SCFM	SLPM		RATIO	SCFM	SLPM	SCFM	
1089	8.9	252	10	89	2430	267	7556	78
1612	12.9	365	16	206	5635	618	17489	81
2021	21.5	608	20	430	11739	1290	36507	82
2235	35.2	997	22	774	21928	2323	65784	83
2450	50	1415	24	1200	33960	3600	101880	84

Adjustable Air Booster Dimensions

MODEL #		A	B	C	D	E	F	G	H	J
1089	mm	38	19	57	11	18	14	27	32	1/8" NPT
1612	mm	51	32	73	21	25	19	35	44	1/4" NPT
2021	mm	79	51	83	42	27	19	38	70	3/8" NPT
2235	mm	102	76	103	56	31	32	46	89	1/2" NPT
2450	mm	127	102	127	77	38	44	54	114	1/2" NPT











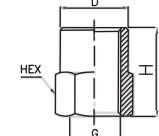

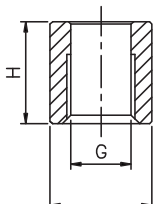

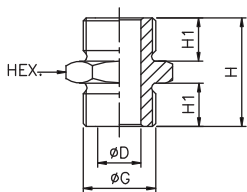
NIPPLES, LOCKNUTS & INTERNAL FILTERS

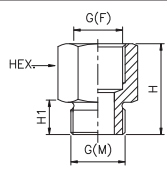
We offer a range of nipples and locknuts in different types and materials to suit most of our customers requirements. Produced in high quality materials and under strict tolerances they ensure a precise and reliable assembly with all nozzles. In your system small size filters ensure individual protection against clogging for individual low capacity nozzles.

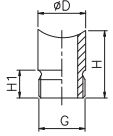
PIPE CLAMPS AND SWIVEL JOINTS

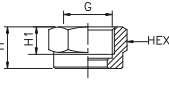

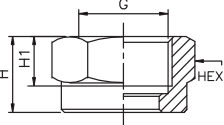

The most extensive range of nozzle clamps engineered for industrial applications to give your system a modern and efficient design with the added value of an easy and well kept at peak performance and long periods of time. Three series of swivels in a wide size range allow the proper connection and quick pointing of the nozzles in your system, improving its overall performances. Swivel joints are available in brass and several stainless steel qualities.

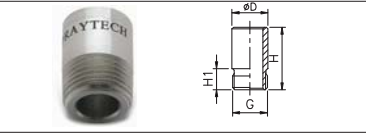
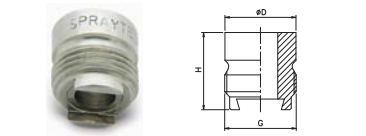
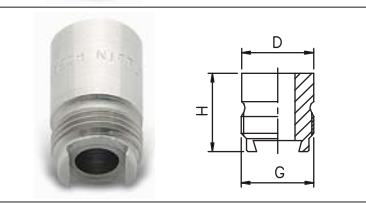
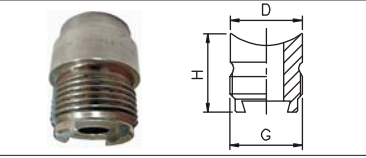
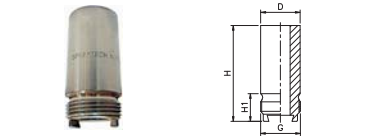
 	Connector (ACC001)	CONNECTION	H	H1	D				
		3/8"	18	10	17.5				
 	COUPLING (ACC002)	CONNECTION	H	D					
		1/8"	14	16					
		1/4"	20	20					
		3/8"	20	22					
		1/2"	25	27					
 	NIPPLE (ACC003)	CONNECTION	H	H1	HEX				
		3/8" X 1/4"	25	10	22				
		3/8" X 3/8"	25	10	22				
		3/8" X 1/2"	28	10	27				
 	SOCKET (ACC004)	CONNECTION	H	H1	HEX				
		3/8" X 1/8"	20	10	22				
		3/8" X 1/4"	24	10	22				
 	WELDING NIPPLE With Radius (ACC201)	CONNECTION	H	H1	D				
		3/8"	18	11.5	17.5				
 	LOCK NUTS 3/8" (ACC302)	CONNECTION	H	H1	HEX				
						3/8"BSPP	13	9.8	22
						3/4"BSPP	16	13	32
 	RETAINING LOCK NUTS 3/4" (ACC301)	CONNECTION	H	H1	HEX				
						1"BSPP	38	32	41

Accessories Welding Nipple

	Welding Nipple (ACC202)	CONNECTION	H	H1	D
		3/8" BSPP	18	11.5	17.2
		3/4" BSPP	27	15.5	28
	Welding Nipple Dovetail (ACC203)	CONNECTION	H	H1	D
		3/8" BSPP	18	11.5	17
		3/8" BSPP	28	11.5	17
	Dovetail Nipple (ACC204)	CONNECTION	H	H1	D
		3/4" BSPP	27	15.5	28
		3/4" BSPP	35	15.5	28
	Dovetail Nipple With Radius (ACC205)	CONNECTION	H	H1	D
		1" BSPP	50	24	38
		1" BSPP	120	24	44
	Dovetail Nipple (ACC205)	CONNECTION	H	H1	D
		1 1/4" BSPP	40	24	42

Accessories Boll Joint

	(ACC401)	CONNECTION	H	H1	HEX	
		1/8"(M) X 1/8"(F)	35	6.5	22/22	
		1/4"(M) X 1/4"(F)	43.5	10	24/27	
	(ACC401)	CONNECTION	H	H1	HEX	
		3/8"(M) X 3/8"(F)	40	10.1	27/30	
		3/8"(M) X 1/4"(F)	43.5	10.1	24/27	
	(ACC402)	CONNECTION	H	H1	HEX	
		1/2"(M) X 1/2"(F)	61	13.2	41/41	
		3/4"(M) X 3/4"(F)	61	14.5	42/42	
	(ACC403)	CONNECTION	H	H1	D	
		1"	90	22	90	
		1 1/2"	130	30	90	
	clamp (ACC404)	PIPE	MOC	H1	H2	D
		1/2"	PP/PVC	36	16	20/22
		3/4"	PP/PVC	40	17	25/27
		1"	PP/PVC	44	21	32/35